

Type D Cycle Stand

1000W x 1000H

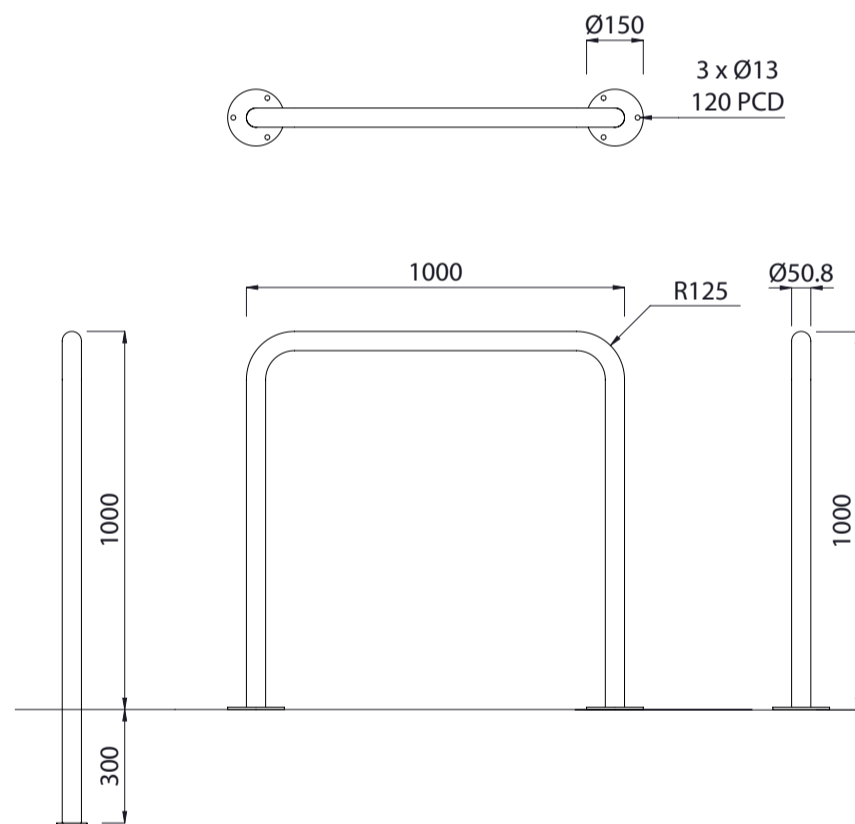

Colours / finishes shown are indicative only and may differ in reality.



	MATERIALS	FINISHES	FINISH OPTIONS
Steelwork	<ul style="list-style-type: none"> Mild steel 304 Stainless steel 316 Stainless steel 	<ul style="list-style-type: none"> Hot dip galvanised only or Hot dip galvanised and powdercoated Electropolished as standard Electropolished or Bead blasted 	<ul style="list-style-type: none"> Custom paint options
	OPTIONS	DIMENSIONS	WEIGHT
	<ul style="list-style-type: none"> Plant or Surface Mounted 	<ul style="list-style-type: none"> 475L x 1000H x Ø50.8 600L x 1000H x Ø50.8 800L x 1000H x Ø50.8 1000L x 1000H x Ø50.8 	<ul style="list-style-type: none"> 7Kg 7.5Kg 8Kg 8.5Kg

- Made to order and can be customised to suit clients requirements.
- Furniture is not supplied with installation instructions, install fastenings or footing details. These are to be specified and determined by the installing contractor for the specific requirements of each site.