

Curbside Cycle Rack 3 Berth

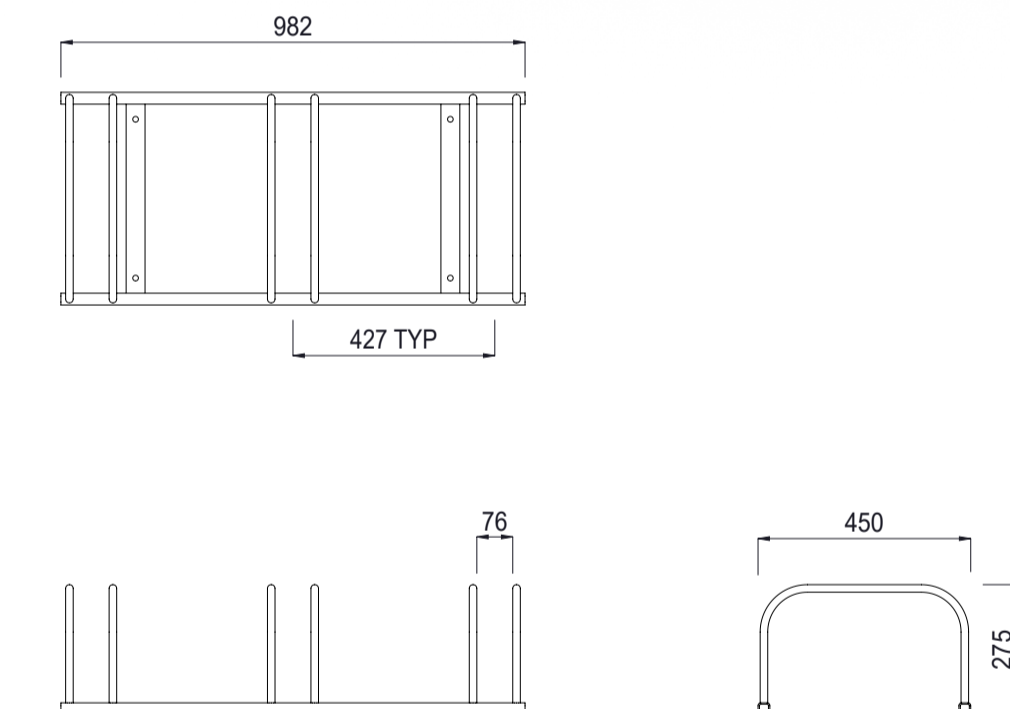

Colours / finishes shown are indicative only and may differ in reality.



	MATERIALS	FINISHES	FINISH OPTIONS
Steelwork	<ul style="list-style-type: none"> Mild steel as standard 	<ul style="list-style-type: none"> Hot dip galvanised and powdercoated 	<ul style="list-style-type: none"> Custom paint options
	OPTIONS	DIMENSIONS	WEIGHT
<ul style="list-style-type: none"> Surface mounted as standard Custom berth quantities Berths angled at 45° 		<ul style="list-style-type: none"> 982L x 275H x 450D 	<ul style="list-style-type: none"> 13Kg

- **Not suitable for bikes with disc brakes**
- Made to order and can be customised to suit clients requirements.
- Furniture is not supplied with installation instructions, install fastenings or footing details. These are to be specified and determined by the installing contractor for the specific requirements of each site.